

datavideo

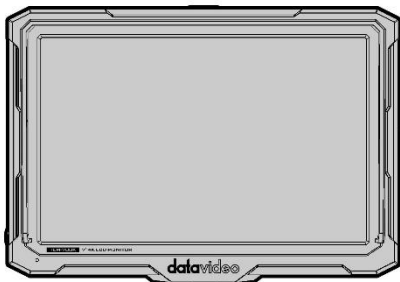

**4K UHD
7" LCD MONITOR
TLM-700UHD**
Instruction Manual

www.datavideo.com

Table of Contents

FCC COMPLIANCE STATEMENT	3
WARNINGS AND PRECAUTIONS	3
WARRANTY	4
STANDARD WARRANTY	4
THREE YEAR WARRANTY	5
DISPOSAL	6
1. INTRODUCTION	7
TLM-700UHD MODEL TYPE	8
COMPATIBLE RESOLUTIONS AND FORMATS	9
2. CONNECTIONS AND CONTROLS	12
3. OSD MENU	17
4. DIMENSIONS	24
5. FIRMWARE UPGRADE PROCEDURE	26
6. SPECIFICATIONS	29
7. ACCESSORIES	31
8. SERVICE AND SUPPORT	35

Disclaimer of Product & Services

The information offered in this instruction manual is intended as a guide only. At all times, Datavideo Technologies will try to give correct, complete and suitable information. However, Datavideo Technologies cannot exclude that some information in this manual, from time to time, may not be correct or may be incomplete. This manual may contain typing errors, omissions or incorrect information. Datavideo Technologies always recommend that you double check the information in this document for accuracy before making any purchase decision or using the product. Datavideo Technologies is not responsible for any omissions or errors, or for any subsequent loss or damage caused by using the information contained within this manual. Further advice on the content of this manual or on the product can be obtained by contacting your local Datavideo Office or dealer.

FCC Compliance Statement

This device complies with part 15 of the FCC rules. Operation is subject to the following two conditions:

1. This device may not cause harmful interference, and
2. This device must accept any interference received, including interference that may cause undesired operation.

Warnings and Precautions

1. Read all of these warnings and save them for later reference.
2. Follow all warnings and instructions marked on this unit.
3. Unplug this unit from the wall outlet before cleaning. Do not use liquid or aerosol cleaners. Use a damp cloth for cleaning.
4. Do not use this unit in or near water.
5. Do not place this unit on an unstable cart, stand, or table. The unit may fall, causing serious damage.
6. Slots and openings on the cabinet top, back, and bottom are provided for ventilation. To ensure safe and reliable operation of this unit, and to protect it from overheating, do not block or cover these openings. Do not place this unit on a bed, sofa, rug, or similar surface, as the ventilation openings on the bottom of the cabinet will be blocked. This unit should never be placed near or over a heat register or radiator. This unit should not be placed in a built-in installation unless proper ventilation is provided.
7. This product should only be operated from the type of power source indicated on the marking label of the AC adapter. If you are not sure of the type of power available, consult your Datavideo dealer or your local power company.
8. Do not allow anything to rest on the power cord. Do not locate this unit where the power cord will be walked on, rolled over, or otherwise stressed.
9. If an extension cord must be used with this unit, make sure that the total of the ampere ratings on the products plugged into the extension cord do not exceed the extension cord rating.
10. Make sure that the total amperes of all the units that are plugged into a single wall outlet do not exceed 15 amperes.

11. Never push objects of any kind into this unit through the cabinet ventilation slots, as they may touch dangerous voltage points or short out parts that could result in risk of fire or electric shock. Never spill liquid of any kind onto or into this unit.
12. Except as specifically explained elsewhere in this manual, do not attempt to service this product yourself. Opening or removing covers that are marked "Do Not Remove" may expose you to dangerous voltage points or other risks, and will void your warranty. Refer all service issues to qualified service personnel.
13. Unplug this product from the wall outlet and refer to qualified service personnel under the following conditions:
 - a. When the power cord is damaged or frayed;
 - b. When liquid has spilled into the unit;
 - c. When the product has been exposed to rain or water;
 - d. When the product does not operate normally under normal operating conditions. Adjust only those controls that are covered by the operating instructions in this manual; improper adjustment of other controls may result in damage to the unit and may often require extensive work by a qualified technician to restore the unit to normal operation;
 - e. When the product has been dropped or the cabinet has been damaged;
 - f. When the product exhibits a distinct change in performance, indicating a need for service.

Warranty

Standard Warranty

- Datavideo equipment is guaranteed against any manufacturing defects for one year from the date of purchase.
- The original purchase invoice or other documentary evidence should be supplied at the time of any request for repair under warranty.
- The product warranty period begins on the purchase date. If the purchase date is unknown, the product warranty period begins on the thirtieth day after shipment from a Datavideo office.

- All non-Datavideo manufactured products (product without Datavideo logo) have only one year warranty from the date of purchase.
- Damage caused by accident, misuse, unauthorized repairs, sand, grit or water is not covered under warranty.
- Viruses and malware infections on the computer systems are not covered under warranty.
- Any errors that are caused by unauthorized third-party software installations, which are not required by our computer systems, are not covered under warranty.
- All mail or transportation costs including insurance are at the expense of the owner.
- All other claims of any nature are not covered.
- All accessories including headphones, cables, batteries, metal parts, housing, cable reel and consumable parts are not covered under warranty.
- Warranty only valid in the country or region of purchase.
- Your statutory rights are not affected.
-

Three Year Warranty

All Datavideo products purchased after July 1st, 2017 qualify for a free two years extension to the standard warranty, providing the product is registered with Datavideo **within 30** days of purchase.



- Certain parts with limited lifetime expectancy such as LCD panels, DVD drives, Hard Drive, Solid State Drive, SD Card, USB Thumb Drive, Lighting, Non-PCIe Card and third party provided PC components are covered for 1 year.
- The three-year warranty must be registered on Datavideo's official website or with your local Datavideo office or one of its authorized distributors within 30 days of purchase.

Disposal



For EU Customers only - WEEE Marking.

This symbol on the product indicates that it should not be treated as household waste. It must be handed over to an applicable take-back scheme for the recycling of Waste Electrical and Electronic Equipment. For more detailed information about the recycling of this product, please contact your local Datavideo office or your local recycling centre.

1. Introduction

The Datavideo TLM-700UHD 7" 4K LCD Monitor features 4K inputs at the 7" screen size. It's UHD 4K resolution is compatible with 16:9 Aspect Ratio LCD field monitor which presents its images on a Full HD 1920x1200 LCD panel.

Optimized for use with the professional DSLRs & Camcorders. It offers a wide range of professional features including focus assist (peaking), false color filters, a variety of screen markers, underscan mode, check field and Pixel-to-Pixel mode.

The Datavideo TLM-700UHD is an excellent display with advanced auxiliary functions to provide wonderful viewing & user friendly experience.

Features

- 4K HDMI input with loop-through output
- F1 user-definable buttons to custom auxiliary functions as shortcut
- DSLR Scaling for Full Screen Viewing
- 170° Horizontal & Vertical wide viewing angle
- 7 inch,1920×1200 full HD resolution
- Portable, slim design
- Individual adjustments of Brightness, Contrast, Saturation, Sharpness
- Color Match Conversion with Color Temperature Adjustment
- Adjustable Screen Markers
- Support Focus assist (peaking), False Color, Histogram, Exposure, Zoom, Pixel to Pixel, Underscan, Check Field (blue-only mode, monochrome mode), etc.
- Multi-format compatibility accommodates virtually all video formats including NTSC/PAL, 480i/p, 720p, 1080i/p,2160p

- 75mm VESA and hot shoe mounts for fixing on the top of camera or camcorder

TLM-700UHD Model Type

Model	TLM-700UHD
Image	
System	Optimized for use with the professional DSLRs & Camcorders

Compatible Resolutions and Formats

Format	TLM-700UHD Interface
	HDMI
4096×2160p @23.98	Support
4096×2160p @24	Support
4096×2160p @25	Support
4096×2160p @29.97	Support
4096×2160p @30	Support
4096×2160p @50	Support
4096×2160p @59.94	Support
4096×2160p @60	Support
3840×2160p @23.98	Support
3840×2160p @24	Support
3840×2160p @25	Support
3840×2160p @29.97	Support
3840×2160p @30	Support
3840×2160p @50	Support
3840×2160p @59.94	Support

3840×2160p @60	Support
2048×1080p @50	Support
2048×1080p @59.94	Support
2048×1080p @60	Support
1920×1080p @59.94	Support
1920×1080p @60	Support
1920×1080p @50	Support
1920×1080p @29.97	Support
1920×1080p @25	Support
1920×1080p @30	Support
1920×1080p @23.98	Support
1920×1080p @24	Support
1920×1080i @59.94	Support
1920×1080i @60	Support
1920×1080i @50	Support
1280×720p @59.94	Support
1280×720p @60	Support
1280×720p @50	Support
1280×720p @23.98	Support

1280×720p @24	Support
1280×720p @25	Support
1280×720p @29.97	Support
1280×720p @30	Support
720×480i @59.94	Support
720×480i @60	Support
720×480p @59.94	Support
720×480p@60	Support
720×576i@50	Support
720×576p@50	Support

2. Connections and Controls

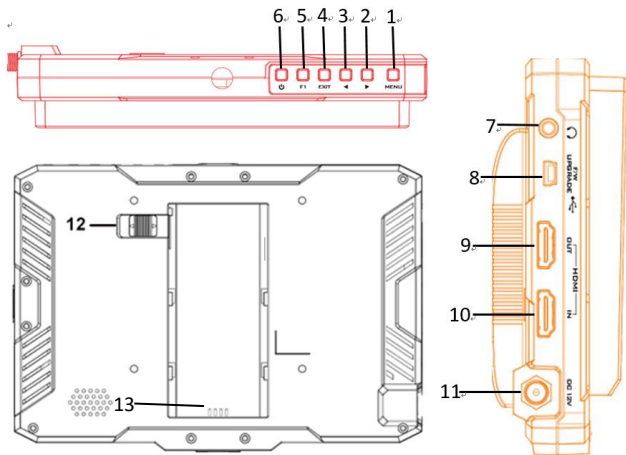

Item	Buttons	Description
1	MENU Button	<p>Menu Function: press this button to activate the OSD menu which is displayed on the screen.</p> <p>Shortcut Functions: Press the left/right button, the volume adjusting bar will appear at the bottom of the screen. At this time, press the menu button to select brightness,</p>

		<p>contrast, saturation, tint, sharpness and Exit.</p> <p>Confirm Function:</p> <ol style="list-style-type: none"> 1. Press the menu button once to show the OSD menu. 2. After the OSD menu is shown, press the menu button once to highlight the menu option and it is ready to navigate the OSD menu by using the left/right button. 3. After that, press the left/right button to select the option that you want to adjust. After the option is selected, press the menu button once and then press the left/right button can adjust the value/mode of the option. 4. After the value is adjusted to your desired value or mode, press the menu button once can confirm that setting.
2 & 3	Right/Left Button	<p>Option Function: Select the options in the menu via pressing to the left/right buttons.</p> <p>Shortcut Function: Press the left/right button and then the volume adjusting bar will appear at the bottom of the screen. After that, user can adjust the parameters of the selected item by pressing the left or right button to meet their needs.</p>

4	EXIT Button	Press this button to go back to previous step or to exit the OSD menu.
5	F1 Button	<p>Long press any F1 key for 3-5 seconds to pop-up a shortcut menu directly.</p> <p>After the pop-up shortcut menu is shown, press the F1 button to set the value or mode of that shortcut option, then press EXIT to exit.</p> <p>Function of F1 button can also be customized as one of following functions : Center Marker, Aspect Marker, Check Field, Underscan, Scan, Aspect, DSLR, Freeze, Peaking, False Color, Exposure, Histogram, Level Meter.</p> <p>Default function: F1: Peaking</p>
6	Power Button	Press the power button to turn ON/OFF the monitor.
7	Headphone Socket	3.5mm headphone socket. Internal speaker circuit will automatically mute when headphones are connected.

8	Mini USB	<p>For firmware updates only.</p> <p>Note:</p> <p>1. This mini USB interface is used for firmware update only, please DO NOT turn off the power of the TLM-700UHD when the USB cable is connecting to the mini USB interface or the TLM-700UHD can not be turned off normally.</p> <p>2. This mini USB interface is used for firmware update only. This mini USB interface does not support the USB Power Delivery function. So, please DO NOT use this USB interface for recharging your electronic devices or it will cause power-on failure or abnormal operation of the TLM-700UHD.</p>
9	HDMI Loop Through	<p>Video and Audio Loop out from an HDMI device.</p> <p>Note: If an HDMI source with the HDCP protection mechanism is the source to input into the TLM-700UHD, this input source can be seen only on TLM-700UHD monitor and can not be looped out to any external monitor.</p>

10	HDMI Input	Video and Audio input from an HDMI device.
11	DC In Socket	DC In Socket for connecting the power supply cable.
12	Battery Plate Switch	Slide the switch to the left side before inserting the battery plate into the slot and then slide the switch to the right side to lock the battery plate.
13	Battery Slot	This battery slot is used for inserting Sony F970 battery plate.

3. OSD Menu

The Datavideo TLM-700UHD 7" 4K LCD monitor adopts an OSD menu system to show six main categories including Picture, Marker, Function, Waveform, Audio and System for setting a variety of functions of this 7" 4K LCD Monitor. To display the OSD menu, press the MENU button. This menu system is navigated using the left or right buttons to change a value or to highlight a menu option. Press the MENU button to select an option or confirm a value.

The six main categories of the TLM-700UHD OSD menu is shown as follows.

1. Picture		
PICTURE		
	Brightness	+50
	Contrast	+50
	Saturation	+50
	Tint	+50
	Sharpness	0
	Color Temperature	User
	Red Gain	+128
	Green Gain	+128
	Blue Gain	+128



2. Marker		
-----------	--	--

MARKER

	Center Marker	Off
	Aspect Marker	Off
	Safety Marker	Off
	Marker Color	Black
	Grid	Off
	Marker Mat	Off
	Thickness	2









3. Function

FUNCTION

	Scan	Aspect
	Aspect	Full
	Underscan	Off
	Check Field	Off
	Zoom	X2
	Freeze	Off
	DSLR	Off
		





4. Waveform

WAVEFORM

	Peaking	Off
	Peaking Color	Red
	Peaking Level	+50
	False Color	Off
	Exposure	Off
	Exposure Level	+85
	Histogram	On
		

5. Audio

AUDIO

	Volume	+48
	Level Meter	Off
		
		
		
		

6. System

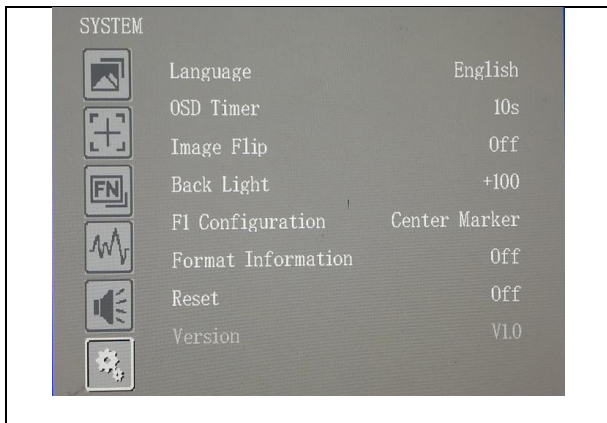

The sub menus and details of the setting values are shown as follows.

Menu	Sub-menu	Value
Picture	Brightness	0~100
	Contrast	0~100
	Saturation	0~100
	Tint	0~100
	Sharpness	0~100

	Color Temp.	6500K/7500K/9300K/User
	Red Gain	0~255
	Green Gain	0~255
	Blue Gain	0~255
	Red Offset	0~511
	Green Offset	0~511
	Blue Offset	0~511
Marker	Center Marker	Off/On
	Aspect Marker	Off/16:9/1.85:1/2.35:1/4:3/3:2/ 9:16
	Safety Marker	Off/95%/93%/90%/88%/85%/80 %
	Marker Color	Red/Green/Blue/White/Black
	Grid	Off/On
	Marker Mat.	Off/1/2/3/4/5/6/7
	Thickness	2/4/6/8

Function	Scan	Aspect/Pixel To Pixel/Zoom
	Aspect	Full/16:9/1.85:1/2.35:1/4:3/3:2
	Underscan	Off/On
	Check Field	Off/Mono/Red/Green/Blue
	Zoom	×1.5/×2/×3/×4
	Freeze	Off/On
	DSLR	Off/5D2/5D3
Waveform	Peaking	Off/On
	Peaking Color	Red/Green/Blue/White/Black
	Peaking Level	0~100
	False Color	Off/On
	Exposure	Off/On
	Exposure Level	0~100
	Histogram	Off/On
Audio	Volume	0~100
	Level Meter	Off/On

System	Language	English/中文
	OSD Timer	10S/20s/30s
	Image Flip	Off/H/V/ H/V
	Back Light	0~100
	F1 Configuration	All Functions
	Format Information	Off/On
	Reset	Off/On
	CPU Version	V1.0
	FPGA Version	V1.0

*The parameters such as Red Gain, Blue Gain, Green Gain, Red Offset, Green Offset and Blue Offset can be activated and shown only when the Color Temp. Option is in user mode.

4. Dimensions

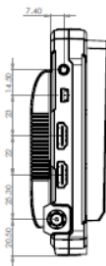
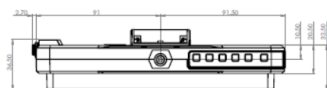
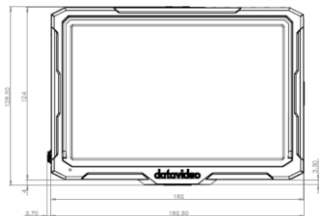

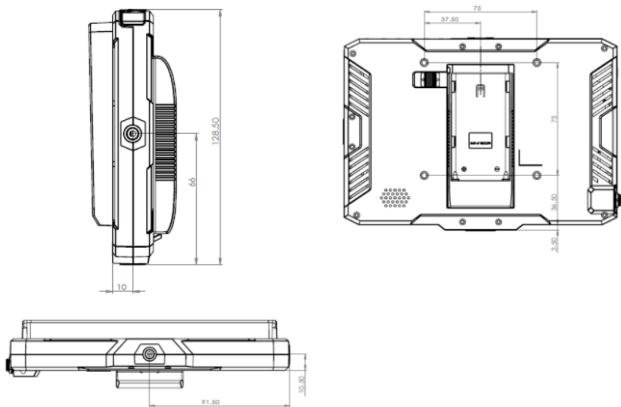

All measurements in millimetres (mm)

5. Firmware Upgrade Procedure

The TLM-700UHD provides a mini USB firmware upgrade interface for users to upgrade the latest CPU and FPGA firmware.

Requirement

- USB female to mini USB transfer cable
- A USB thumb drive

Please follow following steps for upgrading the CPU and FPGA firmware.

● CPU Firmware Upgrade

Step 1. Please prepare a USB female to mini USB transfer cable which is shown as follows.



Step 2. Please copy the CPU firmware upgrade file “MERGE.bin” into the root of the USB thumb drive.

Step 3. Please long-press the EXIT button to enter the engineering mode when the TLM-700UHD is booting.

Step 4. Please select the option “**CPU Update**” and then set this option to “**On**” and then the CPU firmware upgrade procedure will start automatically. It will cost about **20** seconds to finish the firmware update procedure.

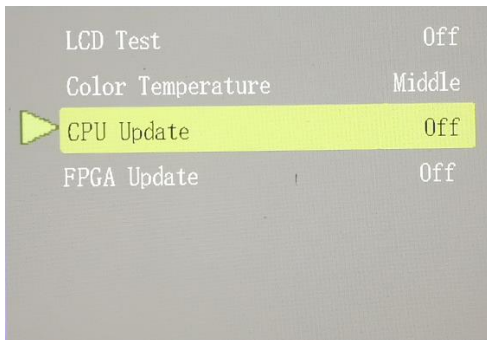

Step 5. After the firmware update is finished, the TLM-700UHD will be turned off automatically. After that, you can check that whether the version number that is shown in the **Version** option on the main OSD menu is updated or not.

- **FPGA Firmware Update**

Step 1. Please prepare a USB female to mini USB transfer cable which is shown as follows.



Step 2. Please copy the FPGA firmware upgrade file “fpga.mcs” into the root of the USB thumb drive.

Step 3. Please long-press the EXIT button to enter the engineering mode when the TLM-700UHD is booting.

Step 4. Please select the option “**FPGA Update**” and then set this option to “**On**” and then the CPU firmware upgrade procedure will start automatically. It will cost about **50** seconds to finish the firmware update procedure.

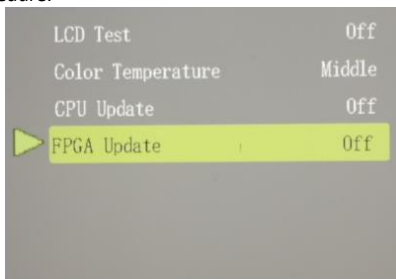

6. Specifications

Model Name	TLM-700UHD
Product Name	7" 4K LCD Monitor
Screen	7" TFT LCD
Chassis	Camera Mount
Resolution	1920 x 1200
Viewing Angle	(H) +85/-85° (V) +85/-85°
Luminance/Contrast	450 cd/m ² 1000:1
Video Inputs	1x HDMI (2.0), HDCP 2.2
Loop Through	1x HDMI (2.0)
Supported Input Resolutions	4096x2160p: 23.98/24/25/29.97/30/50/59.94/60Hz 3840x2160p: 23.98/24/25/29.97/30/50/59.94/60Hz 2048x1080p: 50/59.94/60Hz 1080p: 23.98/24/25/29.97/30/50/59.94/60Hz)50i/59.94i/60i 1080i: 50/59.94/60Hz 720p: 23.98/24/25/29.97/30/50/59.94/60Hz

	576i:50Hz, 576p:50Hz, 480i: 59.94/60Hz), 480p: 59.94/60Hz
Aspect Ratio	Full/16:9/1.85:1/2.35:1/4:3/3:2
Aspect Marker	Off/16:9/1.85:1/2.35:1/4:3/3:2/9:16
Safety Marker	Off/95%/93%/90%/88%/85%/80%
Tally LED	N/A
Audio In/Out	Embedded Audio (48KHz sampling) Analog Stereo (Phone Jack), Speaker x1 (2W)
Special Features	Focus assist (peaking), False Color, Histogram, Exposure, Pixel to Pixel Zoom, Underscan, Check Field(blue-only mode, monochrome mode)
Dimension(L x W x H	182 x 129 x 37 mm
Weight	0.3Kg
Operation Temperature	0°C ~ 40°C(32°F~104°F)
Power	DC 12V, 12 watts

7. Accessories

No.	Accessory	Quantity
1	Folding sun shade cover	1 Piece
2	HDMI A/C cable	1 Piece
3	Battery plate(F970)	1 Piece
4	Hot shoe mount	1 Piece
5	12V adapter	1 Piece

Note

Note

Note

Service & Support

It is our goal to make your products ownership a satisfying experience. Our supporting staff is available to assist you in setting up and operating your system. Please refer to our web site www.datavideo.com for answers to common questions, support requests or contact your local office below.



Please visit our website for latest manual update.

<https://www.datavideo.com/product/TLM-700UHD>

datavideo
www.datavideo.com



@DatavideoUSA @DatavideoIndia2016
@DatavideoEMEA @Datavideojapan
@DatavideoTaiwan @DatavideoLatam
@DatavideoAsia @DatavideoBrasil



@Datavideo
@Datavideo_EMEA
@Datavideo_Taiwan



@DatavideoUSA
@DVTWDCN



@DatavideoUSA
@DatavideoEurope

All the trademarks are the properties of their respective owners.
Datavideo Technologies Co., Ltd. All rights reserved 2020